

Production Worksheet

Wilcom EmbroideryStudio - Designing

ALL YOU 4X4

Design: **All you 4x4**

Title:

Stitches: 19,682
 Height: 95.0 mm
 Width: 91.7 mm
 Colors: 7
 Colorway: Colorway 1
 Zoom: 1.19

z digitizing
 support@zdigitizing.com

Machine format: Tajima
 Color changes: 27
 Stops: 28
 Trims: 42
 Appliqués: 0
 Left: 45.9 mm
 Right: 45.9 mm
 Up: 47.5 mm
 Down: 47.5 mm
 EndX: 0.0 mm
 EndY: 0.0 mm
 Area: 8717.2 mm²
 Max stitch: 9.5 mm
 Min stitch: 0.0 mm
 Max jump: 6.8 mm
 Total thread: 101.51m
 Total bobbin: 35.17m

Stop Sequence:

#	N#	Color	St.	Code	Name	Chart
1.	8		1,642	1321	Bubble Gum Pink	Madeira Classic 40
2.	4		1,794	1000		Madeira Classic 40
3.	5		2,165	1004	Natural White	Madeira Classic 40
4.	2		3,082	1037	Red	Madeira Classic 40
5.	4		3,382	1000		Madeira Classic 40
6.	5		3,537	1004	Natural White	Madeira Classic 40
7.	8		3,639	1321	Bubble Gum Pink	Madeira Classic 40
8.	7		4,686	1017	Orange Wisp	Madeira Classic 40
9.	4		5,090	1000		Madeira Classic 40
10.	2		5,661	1037	Red	Madeira Classic 40
11.	3		6,621	1109	Pink Rose	Madeira Classic 40
12.	8		6,960	1321	Bubble Gum Pink	Madeira Classic 40
13.	5		8,028	1004	Natural White	Madeira Classic 40
14.	4		8,646	1000		Madeira Classic 40
15.	2		9,213	1037	Red	Madeira Classic 40
16.	8		10,379	1321	Bubble Gum Pink	Madeira Classic 40
17.	6		10,782	1481		Madeira Classic 40
18.	2		11,354	1037	Red	Madeira Classic 40
19.	8		11,550	1321	Bubble Gum Pink	Madeira Classic 40
20.	4		11,822	1000		Madeira Classic 40
21.	3		12,115	1109	Pink Rose	Madeira Classic 40
22.	5		13,156	1004	Natural White	Madeira Classic 40
23.	4		13,411	1000		Madeira Classic 40
24.	6		13,568	1481		Madeira Classic 40
25.	2		13,875	1037	Red	Madeira Classic 40
26.	4		17,130	1000		Madeira Classic 40
27.	2		18,155	1037	Red	Madeira Classic 40
28.	6		19,680	1481		Madeira Classic 40



Color Film

Wilcom EmbroideryStudio - Designing

ALL YOU 4X4

Design: **All you 4x4**

Title:

Stitches: 19,682
Height: 95.0 mm
Width: 91.7 mm
Colors: 7
Colorway: Colorway 1
Zoom: 0.50

support@zdigitizing.com

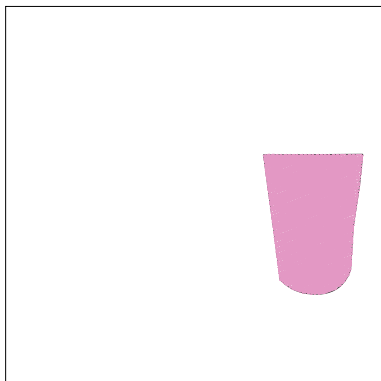

Stop #: 1
Element:
Code: 1321
Name: Bubble Gum Pink
Chart: Madeira Classic 40
Stitches: 1,642
Thread used: 10.55m

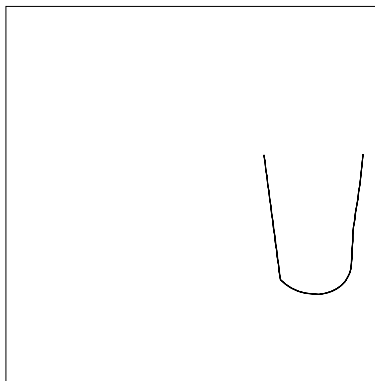

Stop #: 2
Element:
Code: 1000
Name:
Chart: Madeira Classic 40
Stitches: 152
Thread used: 0.66m



Stop #: 3
Element:
Code: 1004
Name: Natural White
Chart: Madeira Classic 40
Stitches: 371
Thread used: 1.47m

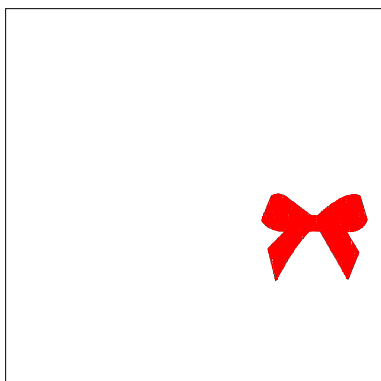

Stop #: 4
Element:
Code: 1037
Name: Red
Chart: Madeira Classic 40
Stitches: 917
Thread used: 5.02m

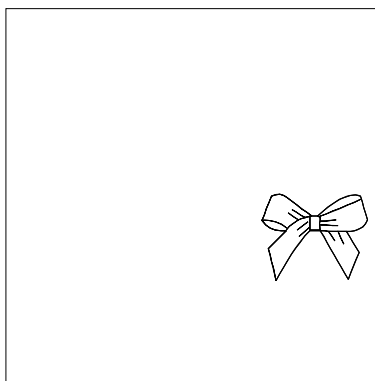

Stop #: 5
Element:
Code: 1000
Name:
Chart: Madeira Classic 40
Stitches: 300
Thread used: 1.21m



Stop #: 6
Element:
Code: 1004
Name: Natural White
Chart: Madeira Classic 40
Stitches: 155
Thread used: 0.63m

Color Film

Wilcom EmbroideryStudio - Designing

ALL YOU 4X4

Design: **All you 4x4**

Title:

Stitches: 19,682
Height: 95.0 mm
Width: 91.7 mm
Colors: 7
Colorway: Colorway 1
Zoom: 0.50

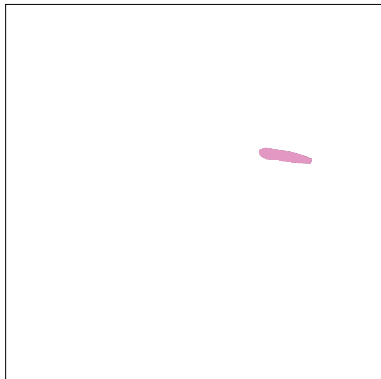

support@zdigitizing.com

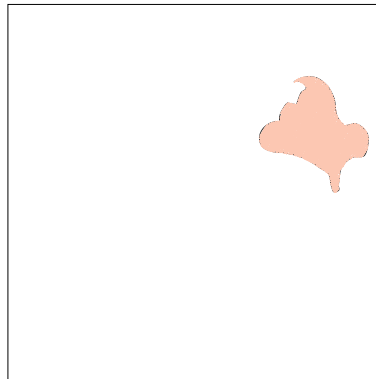

Stop #: 7
Element:
Code: 1321
Name: Bubble Gum Pink
Chart: Madeira Classic 40
Stitches: 102
Thread used: 0.53m

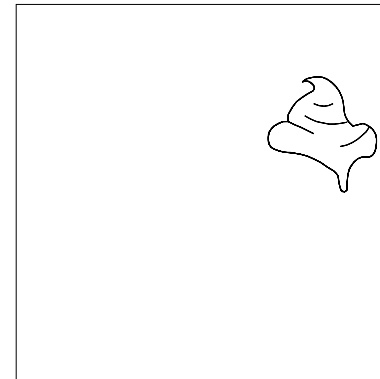

Stop #: 8
Element:
Code: 1017
Name: Orange Wisp
Chart: Madeira Classic 40
Stitches: 1,047
Thread used: 6.08m



Stop #: 9
Element:
Code: 1000
Name:
Chart: Madeira Classic 40
Stitches: 404
Thread used: 1.52m

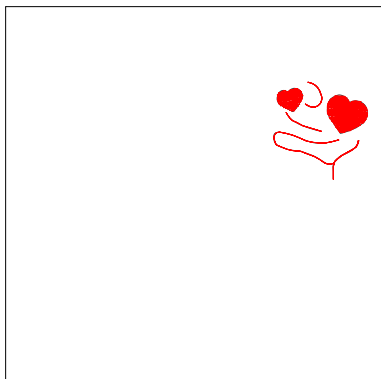

Stop #: 10
Element:
Code: 1037
Name: Red
Chart: Madeira Classic 40
Stitches: 571
Thread used: 2.55m

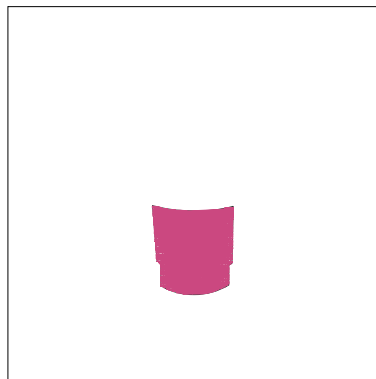

Stop #: 11
Element:
Code: 1109
Name: Pink Rose
Chart: Madeira Classic 40
Stitches: 960
Thread used: 6.02m

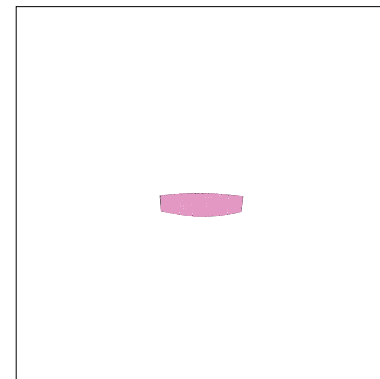

Stop #: 12
Element:
Code: 1321
Name: Bubble Gum Pink
Chart: Madeira Classic 40
Stitches: 339
Thread used: 1.74m

Color Film

Wilcom EmbroideryStudio - Designing

ALL YOU 4X4

Design: **All you 4x4**

Title:

Stitches: 19,682
Height: 95.0 mm
Width: 91.7 mm
Colors: 7
Colorway: Colorway 1
Zoom: 0.50

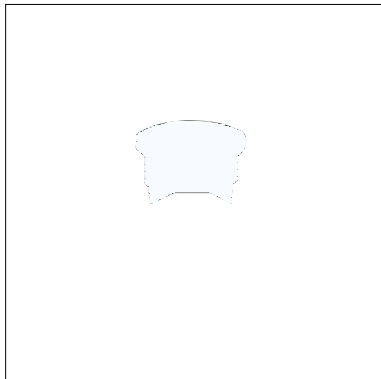

support@zdigitizing.com

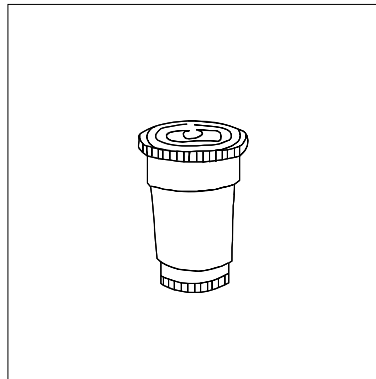

Stop #: 13
Element:
Code: 1004
Name: Natural White
Chart: Madeira Classic 40
Stitches: 1,068
Thread used: 6.70m

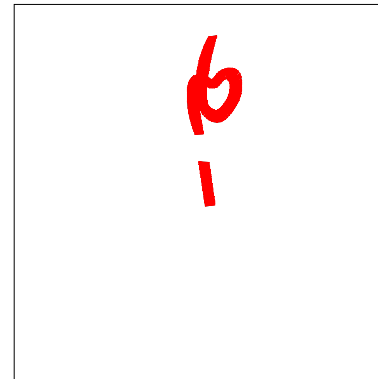

Stop #: 14
Element:
Code: 1000
Name:
Chart: Madeira Classic 40
Stitches: 618
Thread used: 2.40m



Stop #: 15
Element:
Code: 1037
Name: Red
Chart: Madeira Classic 40
Stitches: 567
Thread used: 3.30m

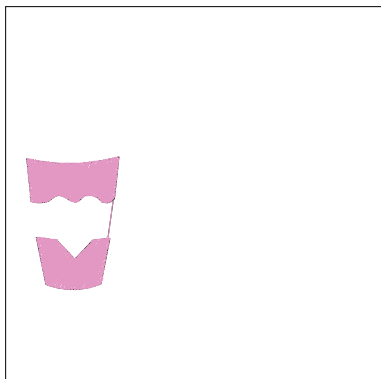

Stop #: 16
Element:
Code: 1321
Name: Bubble Gum Pink
Chart: Madeira Classic 40
Stitches: 1,166
Thread used: 6.47m

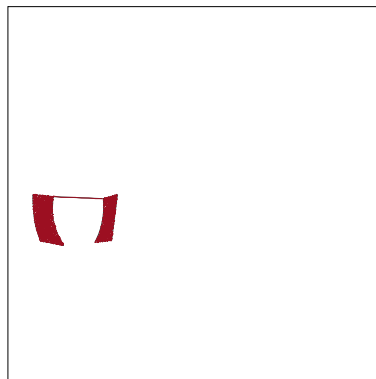

Stop #: 17
Element:
Code: 1481
Name:
Chart: Madeira Classic 40
Stitches: 403
Thread used: 1.90m

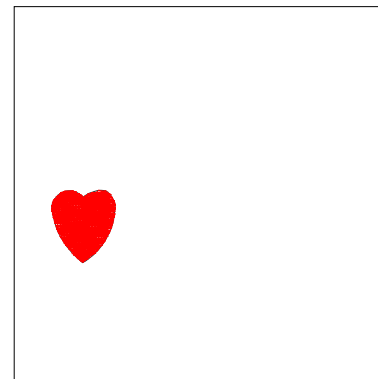

Stop #: 18
Element:
Code: 1037
Name: Red
Chart: Madeira Classic 40
Stitches: 572
Thread used: 3.34m

Color Film

Wilcom EmbroideryStudio - Designing

ALL YOU 4X4

Design: **All you 4x4**

Title:

Stitches: 19,682
Height: 95.0 mm
Width: 91.7 mm
Colors: 7
Colorway: Colorway 1
Zoom: 0.50

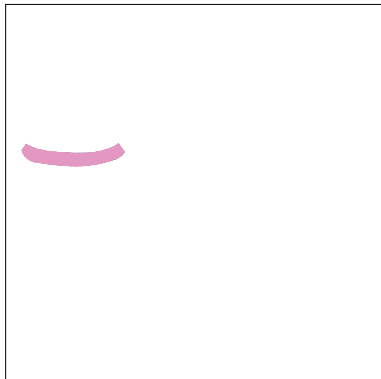

support@zdigitizing.com

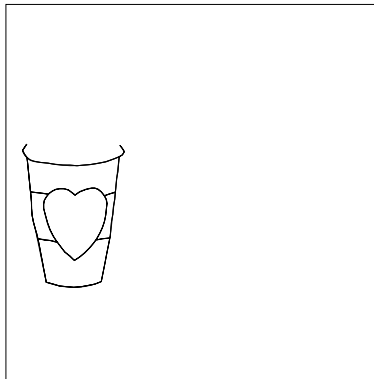

Stop #: 19
Element:
Code: 1321
Name: Bubble Gum Pink
Chart: Madeira Classic 40
Stitches: 196
Thread used: 1.26m

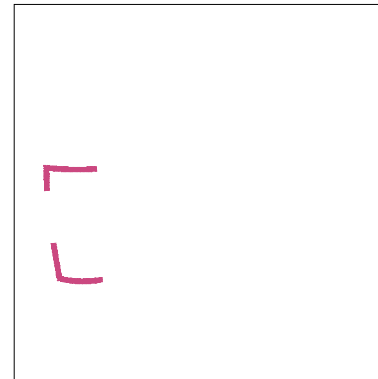

Stop #: 20
Element:
Code: 1000
Name:
Chart: Madeira Classic 40
Stitches: 272
Thread used: 1.13m



Stop #: 21
Element:
Code: 1109
Name: Pink Rose
Chart: Madeira Classic 40
Stitches: 293
Thread used: 1.16m

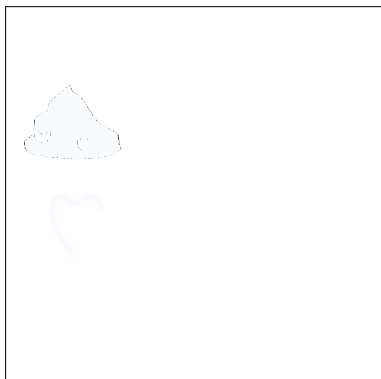

Stop #: 22
Element:
Code: 1004
Name: Natural White
Chart: Madeira Classic 40
Stitches: 1,041
Thread used: 5.26m

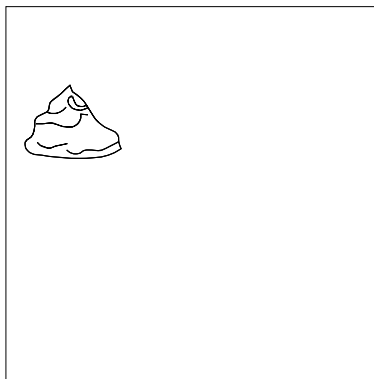

Stop #: 23
Element:
Code: 1000
Name:
Chart: Madeira Classic 40
Stitches: 255
Thread used: 0.92m

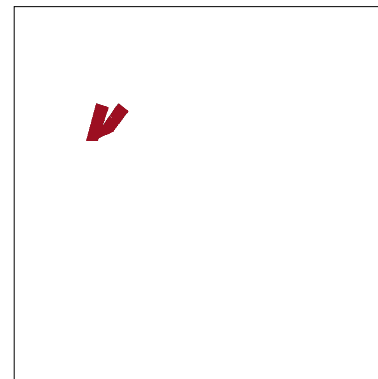

Stop #: 24
Element:
Code: 1481
Name:
Chart: Madeira Classic 40
Stitches: 157
Thread used: 0.89m

Color Film

Wilcom EmbroideryStudio - Designing

ALL YOU 4X4

Design: **All you 4x4**

Title:

Stitches: 19,682
Height: 95.0 mm
Width: 91.7 mm
Colors: 7
Colorway: Colorway 1
Zoom: 0.50

z digitizing
support@zdigitizing.com

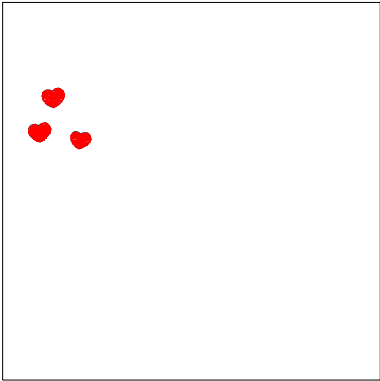

Stop #: 25
Element:
Code: 1037
Name: Red
Chart: Madeira Classic 40
Stitches: 307
Thread used: 1.30m



Stop #: 26
Element:
Code: 1000
Name:
Chart: Madeira Classic 40
Stitches: 3,255
Thread used: 13.86m

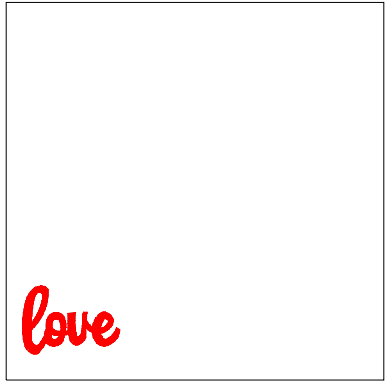

Stop #: 27
Element:
Code: 1037
Name: Red
Chart: Madeira Classic 40
Stitches: 1,025
Thread used: 4.39m

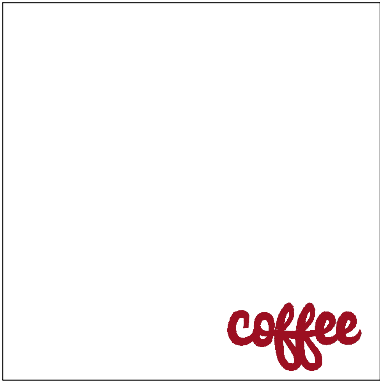

Stop #: 28
Element:
Code: 1481
Name:
Chart: Madeira Classic 40
Stitches: 1,525
Thread used: 6.44m