

# Production Worksheet

Wilcom EmbroideryStudio - Designing

## \*VETERANS DAY C 4X4\*

Design: **Veterans Day C 4x4**











Title:

Stitches: 13,679  
Height: 63.4 mm  
Width: 94.8 mm  
Colors: 6  
Colorway: Colorway 1  
Zoom: 1.22

  
support@zdigitizing.com

Machine format: Tajima  
Color changes: 10  
Stops: 11  
Trims: 30  
Left: 47.4 mm  
Right: 47.4 mm  
Up: 31.7 mm  
Down: 31.7 mm  
EndX: 0.0 mm  
EndY: 0.0 mm  
Area: 6006.3 mm<sup>2</sup>  
Max stitch: 11.1 mm  
Min stitch: 0.2 mm  
Max jump: 6.9 mm

### Stop Sequence:

#	N#	Color	St.	Code	Name	Chart
1.	1		1,121	1134	Royal Blue	Madeira Classic 40
2.	5		2,628	1003	Cream White	Madeira Classic 40
3.	2		4,548	1037	Red	Madeira Classic 40
4.	1		5,105	1134	Royal Blue	Madeira Classic 40
5.	3		5,354	1463		Madeira Classic 40
6.	5		5,923	1003	Cream White	Madeira Classic 40
7.	2		7,252	1037	Red	Madeira Classic 40
8.	6		7,507	1481		Madeira Classic 40
9.	5		10,828	1003	Cream White	Madeira Classic 40
10.	4		11,405	1000	Black	Madeira Classic 40
11.	1		13,677	1134	Royal Blue	Madeira Classic 40



# Color Film

Wilcom EmbroideryStudio - Designing

## \*VETERANS DAY C 4X4\*

Design: **Veterans Day C 4x4**

Title:

Stitches: 13,679  
Height: 63.4 mm  
Width: 94.8 mm  
Colors: 6  
Colorway: Colorway 1  
Zoom: 0.50

  
support@zdigitizing.com

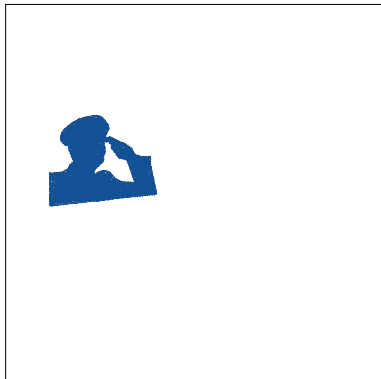

Stop #: 1  
Element:  
Code: 1134  
Name: Royal Blue  
Chart: Madeira Classic 40  
Stitches: 1,121  
Thread used: 5.95m

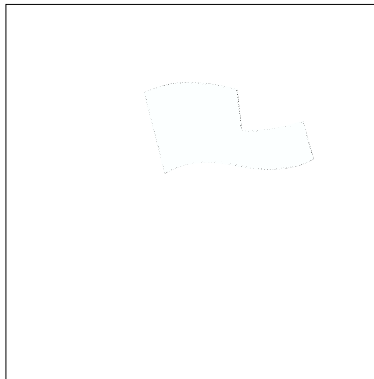

Stop #: 2  
Element:  
Code: 1003  
Name: Cream White  
Chart: Madeira Classic 40  
Stitches: 1,507  
Thread used: 9.24m

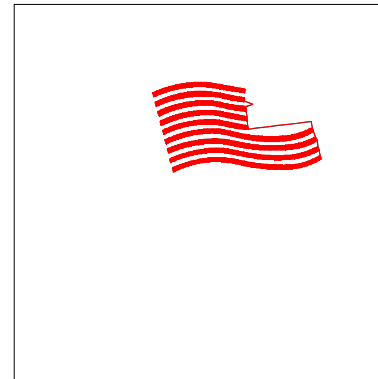

Stop #: 3  
Element:  
Code: 1037  
Name: Red  
Chart: Madeira Classic 40  
Stitches: 1,920  
Thread used: 7.56m

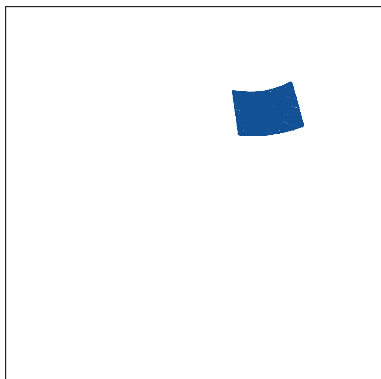

Stop #: 4  
Element:  
Code: 1134  
Name: Royal Blue  
Chart: Madeira Classic 40  
Stitches: 557  
Thread used: 3.14m

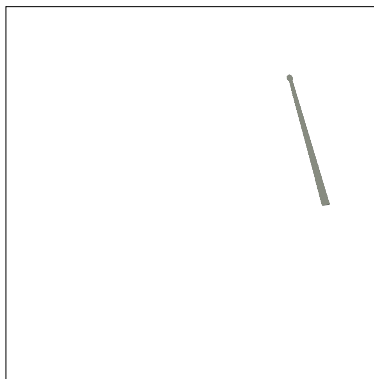

Stop #: 5  
Element:  
Code: 1463  
Name:  
Chart: Madeira Classic 40  
Stitches: 249  
Thread used: 0.97m

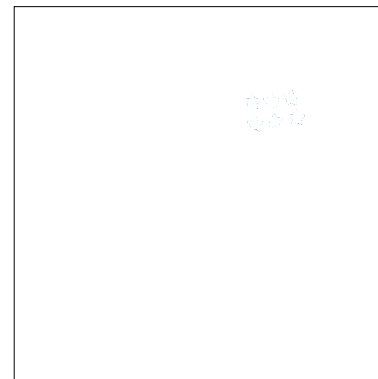

Stop #: 6  
Element:  
Code: 1003  
Name: Cream White  
Chart: Madeira Classic 40  
Stitches: 569  
Thread used: 1.85m

# Color Film

Wilcom EmbroideryStudio - Designing

## \*VETERANS DAY C 4X4\*

Design: **Veterans Day C 4x4**

Title:

Stitches: 13,679  
Height: 63.4 mm  
Width: 94.8 mm  
Colors: 6  
Colorway: Colorway 1  
Zoom: 0.50

  
support@zdigitizing.com

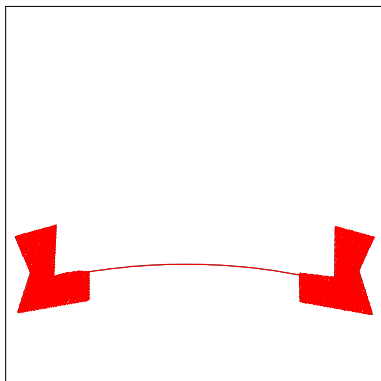

Stop #: 7  
Element:  
Code: 1037  
Name: Red  
Chart: Madeira Classic 40  
Stitches: 1,329  
Thread used: 7.49m

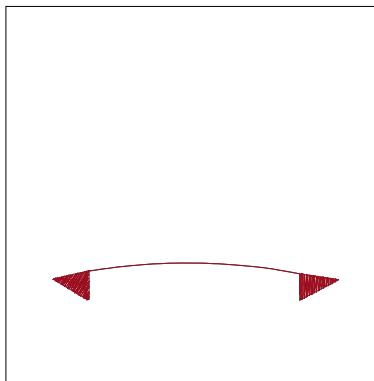

Stop #: 8  
Element:  
Code: 1481  
Name:  
Chart: Madeira Classic 40  
Stitches: 255  
Thread used: 1.12m

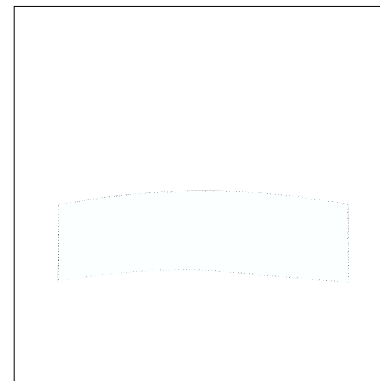

Stop #: 9  
Element:  
Code: 1003  
Name: Cream White  
Chart: Madeira Classic 40  
Stitches: 3,321  
Thread used: 21.55m

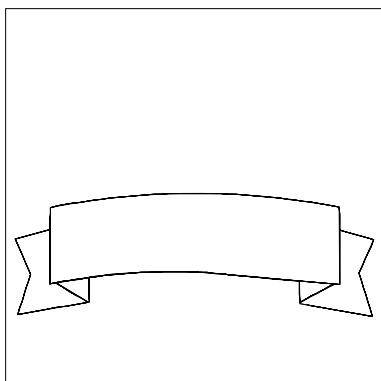

Stop #: 10  
Element:  
Code: 1000  
Name: Black  
Chart: Madeira Classic 40  
Stitches: 577  
Thread used: 2.61m



Stop #: 11  
Element:  
Code: 1134  
Name: Royal Blue  
Chart: Madeira Classic 40  
Stitches: 2,272  
Thread used: 10.06m